

Vordans1

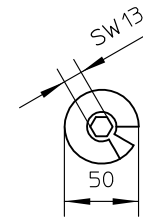

Drfsicht1

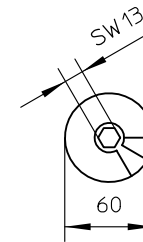
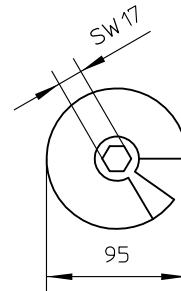
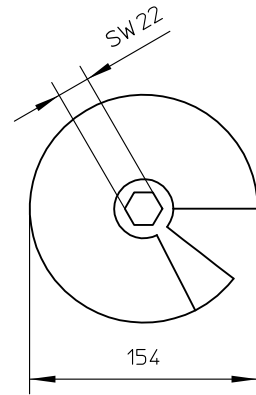
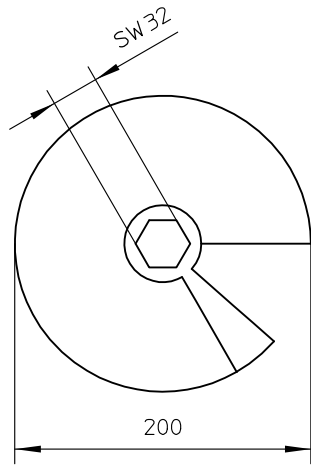
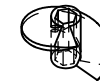
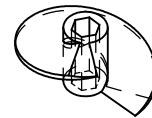
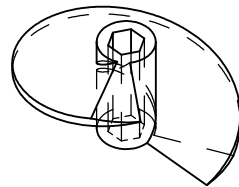
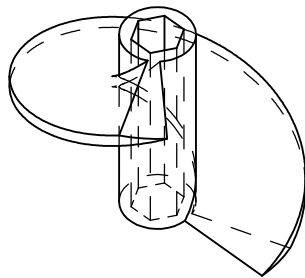

Werkstoff	---	Index	A	B	C	D	E	F	G
---	---	Datum	---	---	---	---	---	---	---
Gez.	18.10.2011	Name	Hubbauer			Projekt		---	
Gep.	---	---	STEINER Spiralförderanlagen						
Mstb	1	Kunststoffschnecken-Übersicht					Auftrag Nr.	---	
Bemärfung	mm						Angebot Nr.	---	
							---	---	
							Blatt Nr.:	1	